



Sofa mit eingeschnittener Struktur aus Massivholz, Rücken- und Armlehnen durch die traditionelle Schwalbenschwanzverbindung miteinander verbunden. Kennzeichen des Sofas ist ein Bewegungseffekt, das dadurch entsteht. Grosse und weiche Sitzkissen aus Leder oder Stoff mit sichtbaren Nähten liegen auf das abgerundete Gestell. Es ist von dem Kunstwerk von Amedeo Modigliani inspiriert worden und so benannt. In zwei Maßen erhältlich.

NUDO

IM FOTO: NUSSBAUM (A1) + LEDER CAMOSCIO (D3)

ART.NR.	MASS	LEDER STOFF	A1	A2
NUDO SOFA	L.239 x T.106 x H.42/72	D1	■	■
		D2	■	■
		D3	■	■
		D4	■	■
		D6	■	■
NUDO ARMCHAIR	L.116 x T.106 x H.42/72	D1	■	■
		D2	■	■
		D3	■	■
		D4	■	■
		D6	■	■

VERFÜGBARE AUSFÜHRUNGEN:

A1: Nussbaum ohne Knoten

A2: Eiche ohne Knoten

D1: Stoff: canvas, divina melange 2, hallingdal 65, Samt harald

D2: Stoff: maple

D3: Leder: camoscio, cristal

D4: Leder: nabuk, utah

D6: Kundenleder, Kundenstoff

NUDO SOFA

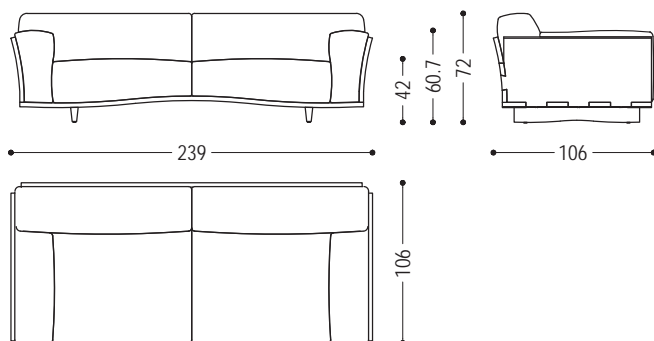

NUDO ARMCHAIR

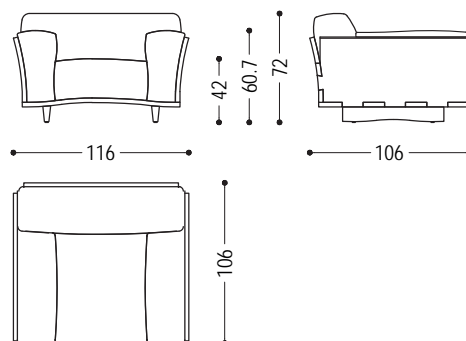

HOLZ

A1

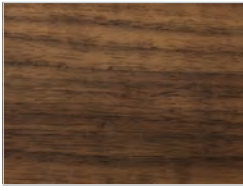

Nussbaum ohne Knoten

A2

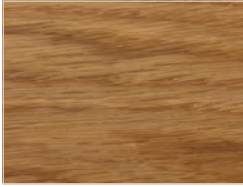

Eiche ohne Knoten

LEDER/STOFFE

D1



Stoff:
canvas:
114

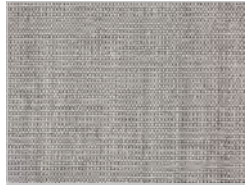

Stoff:
canvas:
124

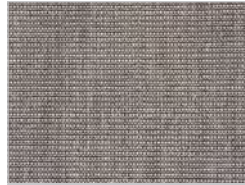

Stoff:
canvas:
134

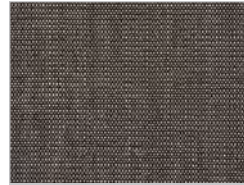

Stoff:
canvas:
154



Stoff:
canvas:
174



Stoff:
divina melange 2:
120



Stoff:
divina melange 2:
170

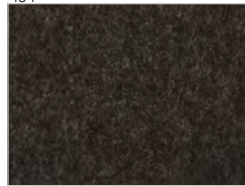

Stoff:
divina melange 2:
180



Stoff:
divina melange 2:
220

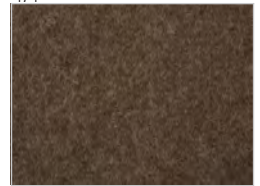

Stoff:
divina melange 2:
260

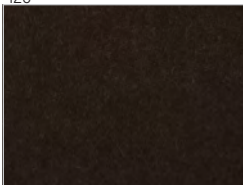

Stoff:
divina melange 2:
280



Stoff:
hallingdal 65:
103



Stoff:
hallingdal 65:
116



Stoff:
hallingdal 65:
130



Stoff:
hallingdal 65:
166



Stoff:
samt harald:
180

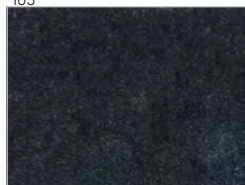

Stoff:
samt harald:
182

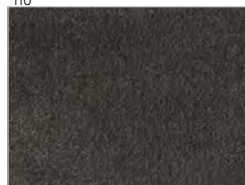

Stoff:
samt harald:
242



Stoff:
samt harald:
- 283

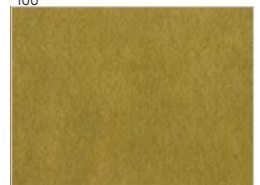

Stoff:
samt harald:
443

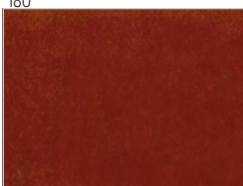

Stoff:
samt harald:
512



Stoff:
samt harald:
552

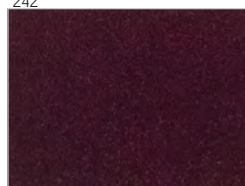

Stoff:
samt harald:
582

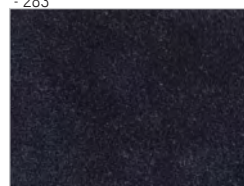

Stoff:
samt harald:
792

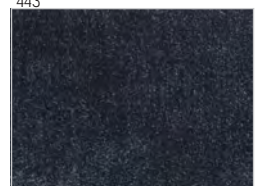

Stoff:
samt harald:
982

NUDO | VERFÜGBARE AUSFÜHRUNGEN

D2



Stoff:
maple:
112



Stoff:
maple:
132



Stoff:
maple:
142



Stoff:
maple:
162



Stoff:
maple:
192



Stoff:
maple:
222



Stoff:
maple:
232



Stoff:
maple:
362

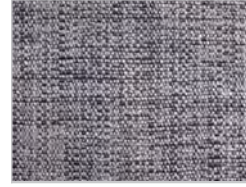

Stoff:
maple:
742



Stoff:
maple:
792

D3



Leder camoscio:
1

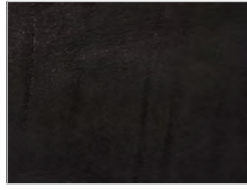

Leder camoscio:
10

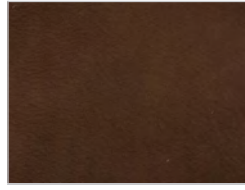

Leder camoscio:
11



Leder camoscio:
26

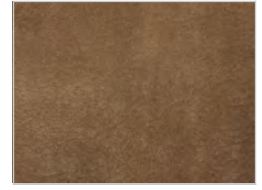

Leder camoscio:
27



Leder camoscio:
28



Leder camoscio:
31

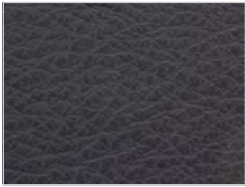

Leder cristal:
13



Leder cristal:
14



Leder cristal:
17



Leder cristal:
18



Leder cristal:
37



Leder cristal:
49



Leder cristal:
51



Leder cristal:
65

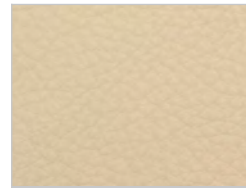

Leder cristal:
70

NUDO | VERFÜGBARE AUSFÜHRUNGEN

D4					
	Leder nabuk: 6	Leder nabuk: 12	Leder nabuk: 15	Leder nabuk: 18	Leder nabuk: 23
					
	Leder nabuk: 27	Leder nabuk: 28	Leder nabuk: 30	Leder nabuk: 36	Leder nabuk: 42
					
	Leder utah: 101	Leder utah: 102	Leder utah: 103	Leder utah: 104	Leder utah: 105
					
	Leder utah: 106	Leder utah: 107	Leder utah: 108		